

LM320L, LM79LXXAC Series 3-Terminal Negative Regulators

General Description

The LM320L/LM79LXXAC series of 3-terminal negative voltage regulators features fixed output voltages of $-5V$, $-12V$, and $-15V$ with output current capabilities in excess of 100 mA. These devices were designed using the latest computer techniques for optimizing the packaged IC thermal/electrical performance. The LM79LXXAC series, even when combined with a minimum output compensation capacitor of $0.1 \mu F$, exhibits an excellent transient response, a maximum line regulation of $0.07\% V_O/V$, and a maximum load regulation of $0.01\% V_O/mA$.

The LM320L/LM79LXXAC series also includes, as self-protection circuitry: safe operating area circuitry for output transistor power dissipation limiting, a temperature independent short circuit current limit for peak output current limiting, and a thermal shutdown circuit to prevent excessive junction temperature. Although designed primarily as fixed voltage regulators, these devices may be combined with simple external circuitry for boosted and/or adjustable voltages and currents. The LM79LXXAC series is available in the 3-lead TO-92 package, and SO-8; 8 lead package. The LM320L series is available in the 3-lead TO-92 package.

For output voltage other than $-5V$, $-12V$ and $-15V$ the LM137L series provides an output voltage range from 1.2V to 47V.

Features

- Preset output voltage error is less than $\pm 5\%$ overload, line and temperature
- Specified at an output current of 100 mA
- Easily compensated with a small $0.1 \mu F$ output capacitor
- Internal short-circuit, thermal and safe operating area protection
- Easily adjustable to higher output voltages
- Maximum line regulation less than $0.07\% V_{OUT}/V$
- Maximum load regulation less than $0.01\% V_{OUT}/mA$

Typical Applications

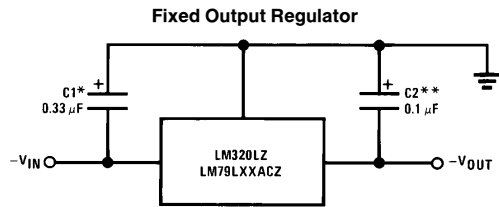

TL/H/7748-1

*Required if the regulator is located far from the power supply filter. A $1 \mu F$ aluminum electrolytic may be substituted.

**Required for stability. A $1 \mu F$ aluminum electrolytic may be substituted.

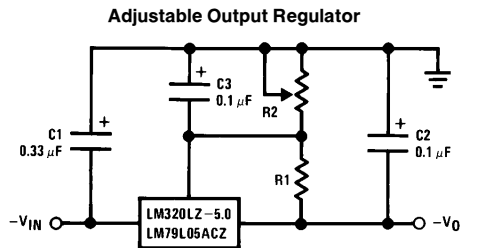

TL/H/7748-3

$$-V_O = -5V - (5V/R1 + I_O) \cdot R2,$$

$$5V/R1 > 3 I_O$$

Connection Diagrams

SO-8 Plastic (Narrow Body)

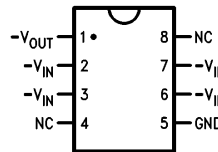

TL/H/7748-4

Top View

Order Number LM79L05ACM,
LM79L12ACM or LM79L15ACM
See NS Package Number M08A

TO-92 Plastic Package (Z)

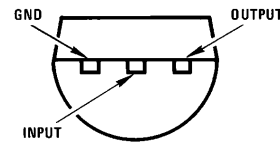

TL/H/7748-2

Bottom View

Order Number LM320LZ-5.0, LM79L05ACZ,
LM320LZ-12, LM79L12ACZ, LM320LZ-15 or
LM79L15ACZ
See NS Package Number Z03A

Absolute Maximum Ratings

If Military/Aerospace specified devices are required, please contact the National Semiconductor Sales Office/Distributors for availability and specifications.

Input Voltage

$$V_O = -5V, -12V, -15V$$

-35V

Internal Power Dissipation (Note 1)

Internally Limited

Operating Temperature Range

0°C to +70°C

Maximum Junction Temperature

+125°C

Storage Temperature Range

-55°C to +150°C

Lead Temperature (Soldering, 10 sec.)

260°C

Electrical Characteristics (Note 2) $T_A = 0^\circ\text{C}$ to $+70^\circ\text{C}$ unless otherwise noted.

Output Voltage			-5V			-12V			-15V			Units	
Input Voltage (unless otherwise noted)			-10V			-17V			-20V				
Symbol	Parameter	Conditions	Min	Typ	Max	Min	Typ	Max	Min	Typ	Max		
V_O	Output Voltage	$T_J = 25^\circ\text{C}, I_O = 100\text{ mA}$	-5.2	-5	-4.8	-12.5	-12	-11.5	-15.6	-15	-14.4	V	
		$1\text{ mA} \leq I_O \leq 100\text{ mA}$	-5.25		-4.75	-12.6		-11.4	-15.75		-14.25		
		$V_{\text{MIN}} \leq V_{\text{IN}} \leq V_{\text{MAX}}$	(-20 $\leq V_{\text{IN}} \leq -7.5$)			(-27 $\leq V_{\text{IN}} \leq -14.8$)			(-30 $\leq V_{\text{IN}} \leq -18$)				
		$1\text{ mA} \leq I_O \leq 40\text{ mA}$	-5.25		-4.75	-12.6		-11.4	-15.75		-14.25		
		$V_{\text{MIN}} \leq V_{\text{IN}} \leq V_{\text{MAX}}$	(-20 $\leq V_{\text{IN}} \leq -7$)			(-27 $\leq V_{\text{IN}} \leq -14.5$)			(-30 $\leq V_{\text{IN}} \leq -17.5$)				
ΔV_O	Line Regulation	$T_J = 25^\circ\text{C}, I_O = 100\text{ mA}$			60			45			45	mV	
		$V_{\text{MIN}} \leq V_{\text{IN}} \leq V_{\text{MAX}}$	(-20 $\leq V_{\text{IN}} \leq -7.3$)			(-27 $\leq V_{\text{IN}} \leq -14.6$)			(-30 $\leq V_{\text{IN}} \leq -17.7$)			V	
		$T_J = 25^\circ\text{C}, I_O = 40\text{ mA}$			60			45			45	mV	
		$V_{\text{MIN}} \leq V_{\text{IN}} \leq V_{\text{MAX}}$	(-20 $\leq V_{\text{IN}} \leq -7$)			(-27 $\leq V_{\text{IN}} \leq -14.5$)			(-30 $\leq V_{\text{IN}} \leq -17.5$)			V	
ΔV_O	Load Regulation	$T_J = 25^\circ\text{C}$ $1\text{ mA} \leq I_O \leq 100\text{ mA}$			50			100			125	mV	
ΔV_O	Long Term Stability	$I_O = 100\text{ mA}$			20			48			60	mV/khrs	
I_Q	Quiescent Current	$I_O = 100\text{ mA}$			2			6			2	6	mA
ΔI_Q	Quiescent Current Change	$1\text{ mA} \leq I_O \leq 100\text{ mA}$			0.3			0.3			0.3	mA	
		$1\text{ mA} \leq I_O \leq 40\text{ mA}$			0.1			0.1			0.1		
		$I_O = 100\text{ mA}$			0.25			0.25				0.25	mA
		$V_{\text{MIN}} \leq V_{\text{IN}} \leq V_{\text{MAX}}$	(-20 $\leq V_{\text{IN}} \leq -7.5$)			(-27 $\leq V_{\text{IN}} \leq -14.8$)			(-30 $\leq V_{\text{IN}} \leq -18$)			V	
V_n	Output Noise Voltage	$T_J = 25^\circ\text{C}, I_O = 100\text{ mA}$ $f = 10\text{ Hz} - 10\text{ kHz}$			40			96			120	μV	
$\frac{\Delta V_{\text{IN}}}{\Delta V_O}$	Ripple Rejection	$T_J = 25^\circ\text{C}, I_O = 100\text{ mA}$ $f = 120\text{ Hz}$			50			52			50	dB	
	Input Voltage Required to Maintain Line Regulation	$T_J = 25^\circ\text{C}, I_O = 100\text{ mA}$			-7.3			-14.6			-17.7	V	
		$I_O = 40\text{ mA}$			-7.0			-14.5			-17.5	V	

Note 1: Thermal resistance of Z package is 60°C/W θ_{JC} , 232°C/W θ_{JA} at still air, and 88°C/W at 400 ft/min of air. The M package θ_{JA} is 180°C/W in still air. The maximum junction temperature shall not exceed 125°C on electrical parameters.

Note 2: To ensure constant junction temperature, low duty cycle pulse testing is used.

Typical Performance Characteristics

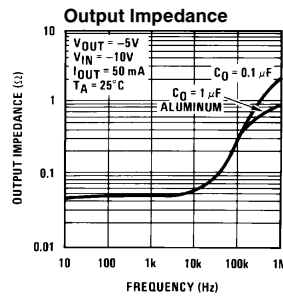
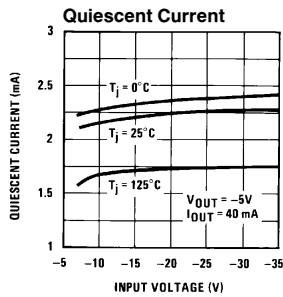
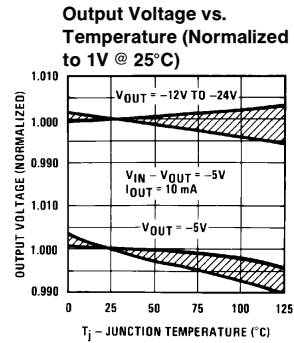
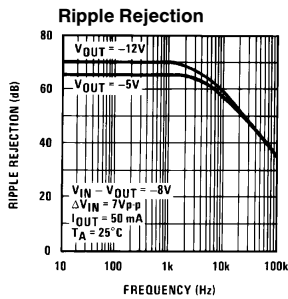
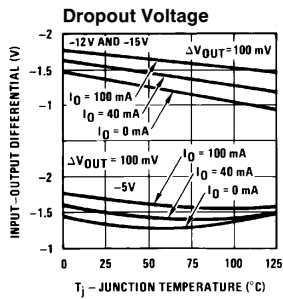
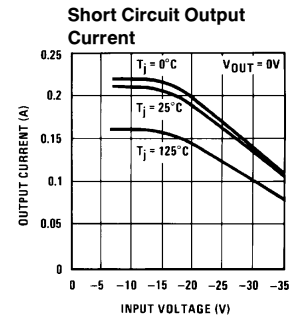
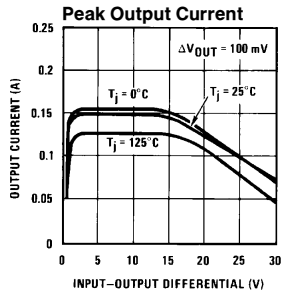
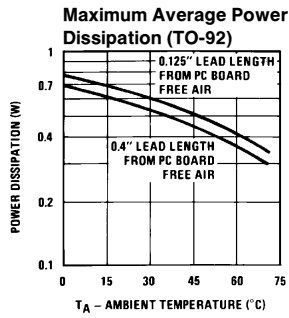

TL/H/7748-5

Typical Applications (Continued)

± 15 V, 100 mA Dual Power Supply

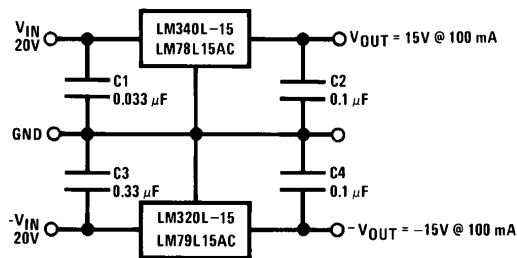

TL/H/7748-6

Schematic Diagrams

-5V

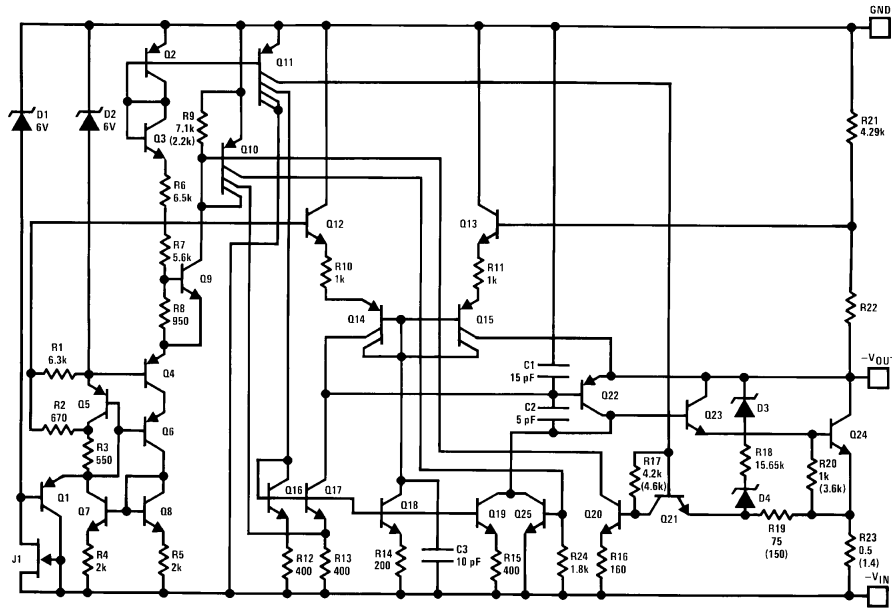

TL/H/7748-9

-12V and -15V

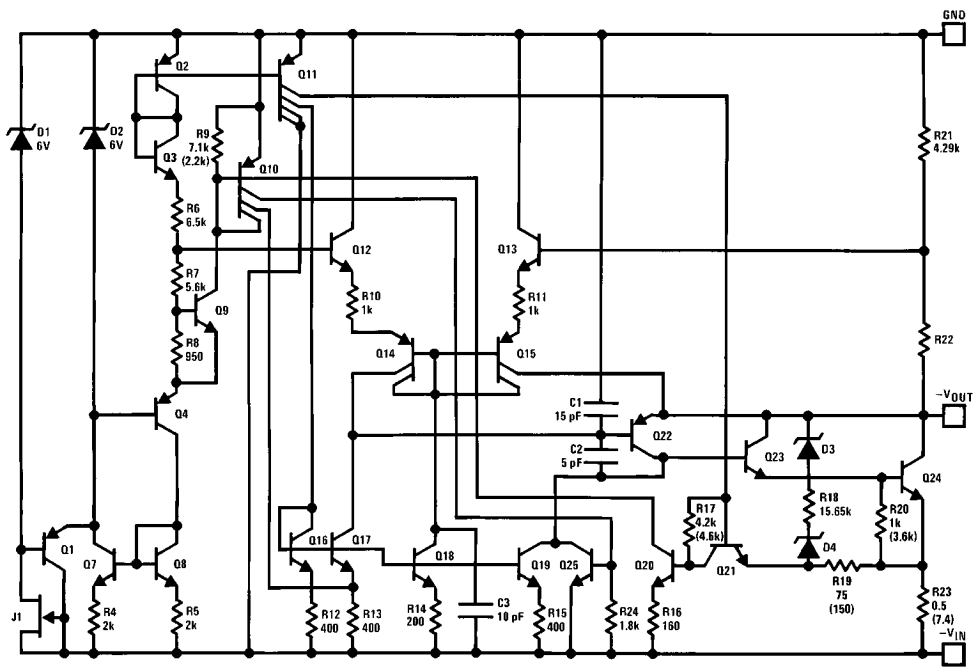

TL/H/7748-10

Physical Dimensions inches (millimeters)

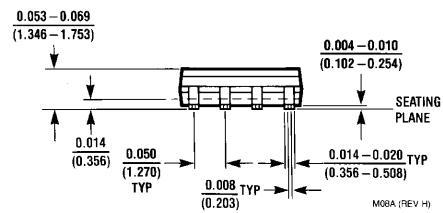
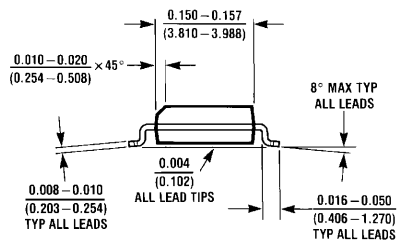
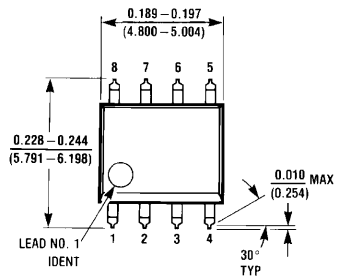

S.O. Package (M)
Order Number LM79L05ACM, LM79L12ACM or LM79L15ACM
NS Package Number M08A

Physical Dimensions inches (millimeters) (Continued)

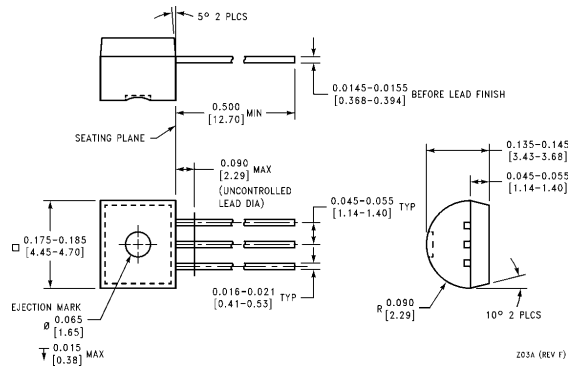

Molded Offset TO-92 (Z)
Order Number LM320LZ-5.0, LM79L05ACZ, LM320LZ-12,
LM79L12ACZ, LM320LZ-15 or LM79L15ACZ
NS Package Number Z03A

LIFE SUPPORT POLICY

NATIONAL'S PRODUCTS ARE NOT AUTHORIZED FOR USE AS CRITICAL COMPONENTS IN LIFE SUPPORT DEVICES OR SYSTEMS WITHOUT THE EXPRESS WRITTEN APPROVAL OF THE PRESIDENT OF NATIONAL SEMICONDUCTOR CORPORATION. As used herein:

1. Life support devices or systems are devices or systems which, (a) are intended for surgical implant into the body, or (b) support or sustain life, and whose failure to perform, when properly used in accordance with instructions for use provided in the labeling, can be reasonably expected to result in a significant injury to the user.
2. A critical component is any component of a life support device or system whose failure to perform can be reasonably expected to cause the failure of the life support device or system, or to affect its safety or effectiveness.



National Semiconductor Corporation
 1111 West Bardin Road
 Arlington, TX 76017
 Tel: 1(800) 272-9959
 Fax: 1(800) 737-7018

National Semiconductor Europe
 Fax: (+49) 0-180-530 85 86
 Email: cnjwge@tevm2.nsc.com
 Deutsch Tel: (+49) 0-180-530 85 85
 English Tel: (+49) 0-180-532 78 32
 Français Tel: (+49) 0-180-532 93 58
 Italiano Tel: (+49) 0-180-534 16 80

National Semiconductor Hong Kong Ltd.
 19th Floor, Straight Block,
 Ocean Centre, 5 Canton Rd.
 Tsimshatsui, Kowloon
 Hong Kong
 Tel: (852) 2737-1600
 Fax: (852) 2736-9960

National Semiconductor Japan Ltd.
 Tel: 81-043-299-2309
 Fax: 81-043-299-2408

National does not assume any responsibility for use of any circuitry described, no circuit patent licenses are implied and National reserves the right at any time without notice to change said circuitry and specifications.